

# Wheel loaders



**WACKER  
NEUSON**



## These reasons speak for wheel loaders from Wacker Neuson.

### 1. Full power – precisely for your requirements

Optimum performance identifies each wheel loader from Wacker Neuson. In this way, you always get the power that you need in all classes – without oversizing your machines.

### 2. Full product range – for varied application all year round

You can outfit a wheel loader from Wacker Neuson with different attachments time and time again for new jobs: from the traditional digging bucket to the pallet fork to the sweeper or the snow plough. In this way you create exactly the all-rounder that you need.

### 3. Full economic efficiency – and in every respect

High quality materials for a long service life. Economic fuel consumption. Good maneuverability for quick loading cycles. Maintenance that is done in no time. We at Wacker Neuson always consider economic efficiency an overall concept.

## Wheel loader expertise down to the last detail.

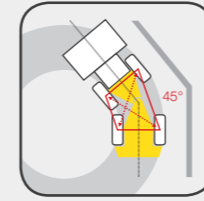

### Maneuverable even in the smallest corners

Due to the articulated pendulum joint, the machines are extremely maneuverable and always have good traction, even in uneven ground conditions.

You can find details on page 16.

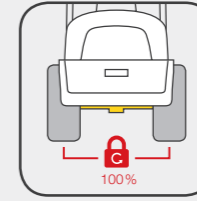

### 100% engageable differential lock

Good traction, even on difficult surfaces, is made possible with the 100% engageable differential lock.

Learn more on page 17.

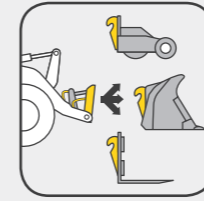

### Numerous connections for attachments

Use the wheel loaders from Wacker Neuson as you need them – the matching hydraulic connections make it possible.



### Comfortable cabin design

The cabins of our wheel loaders offer plenty of comfort through their spacious design and outfitting details.

More on this on page 18.



Wacker Neuson distinguishes particularly economical and environmentally-friendly products with the ECO seal, including the wheel loader WL20e.

## All wheel loaders in an overview.



WL20e



Bucket capacity: 0.2 m<sup>3</sup>  
> Page 06



WL20

0.2 m<sup>3</sup>  
> Page 08



WL25

0.35 m<sup>3</sup>  
> Page 08



WL32

0.45 m<sup>3</sup>  
> Page 08



WL34

0.6 m<sup>3</sup>  
> Page 10



WL38

0.6 m<sup>3</sup>  
> Page 11



WL44

Bucket capacity: 0.75 m<sup>3</sup>  
> Page 12



WL52

0.75 m<sup>3</sup>  
> Page 13



WL54

0.95 m<sup>3</sup>  
> Page 12



WL60

0.95 m<sup>3</sup>  
> Page 14



WL70

1.1 m<sup>3</sup>  
> Page 15

# Wheel loaders from Wacker Neuson offer a solution for everything.

You are adding a true all-rounder to your team with a wheel loader from Wacker Neuson. For the various attachments not only prove themselves in all application areas on the construction site, but also in many other areas and industries.

Trailer coupling for the transport of construction site equipment, such as the light tower.



Powerful hydraulics: perfect for application with a sweeper or snow plow.



Filling with a side dump bucket: good view from the cabin and high level of stability.



Practical for road and path construction: WL32 with surface planer.



Reliable load carrier – and always with a good view of the transport material.



Two sturdy lift cylinders can take even large bucket volumes safely from A to B.



# WL20e

The WL20e is the first purely electrically operated wheel loader from Wacker Neuson. As with all of our wheel loaders, it convinces through time-tested and proven usage characteristics and a high level of performance. The latest technology and its emission-free drive system make it perfect for application in urban areas as well as indoors, such as in greenhouses, parking garages or for building restorations.

**Innovative, electric, emission-free –**  
the wheel loader WL20e.

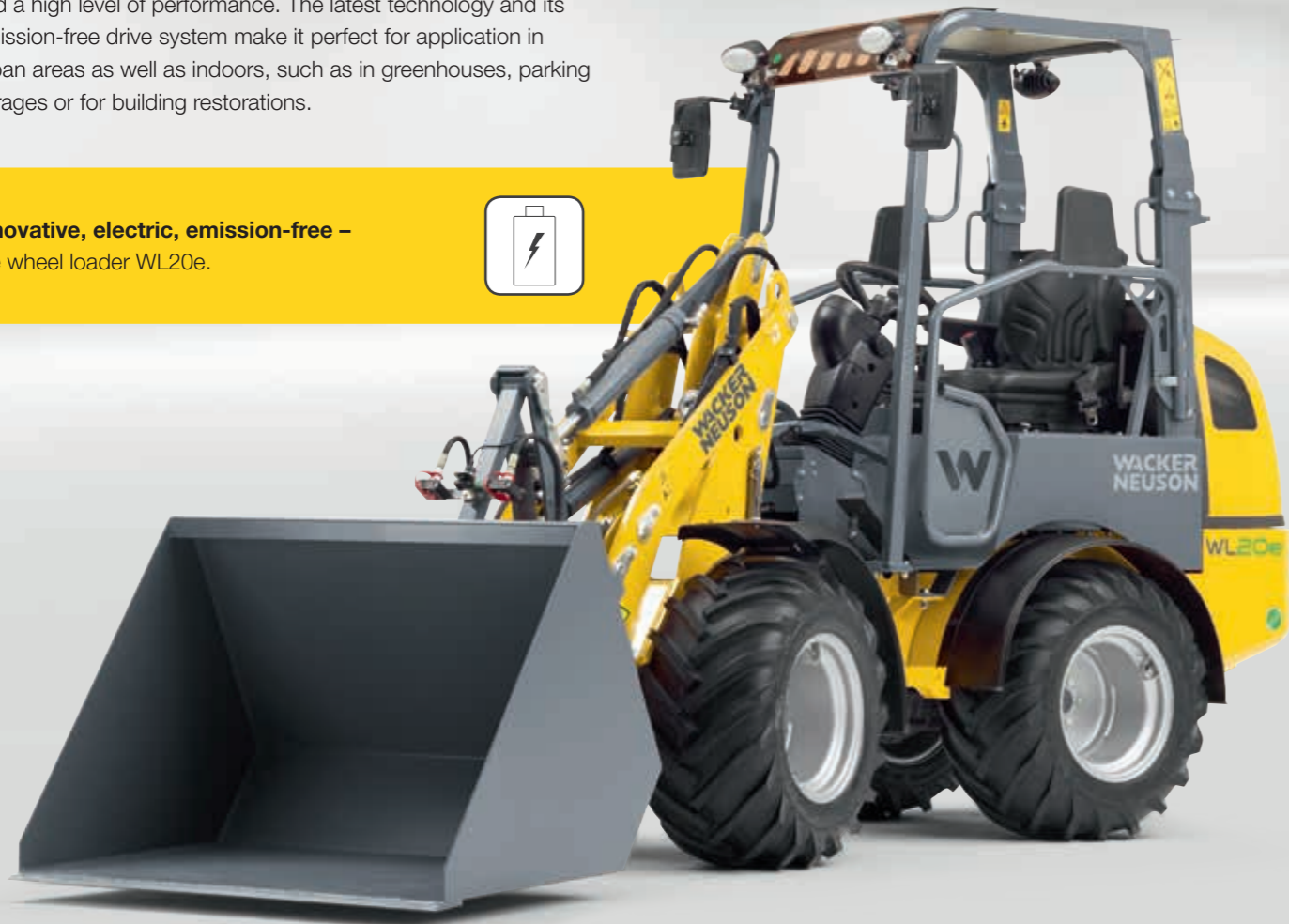

- 100 % emission-free
- Wireless battery drive
- The performance corresponds to that of a diesel-powered wheel loader WL20
- Separate electric motors for the drive system and for the work hydraulics – in this way, performance is requested as needed and the energy consumption is minimized
- Lower noise level for end users and any residents
- Reduced service costs due to less maintenance-intensive elements



**Up to 5 hours of running time** are possible – depending on the type of application – with a fully charged battery (more about this on page 20).



### Operating costs\* for WL20e:

The 20% higher investment costs are amortized with an average machine service life after about 2,800 operating hours.

**Operating costs\*** over the machine's service life

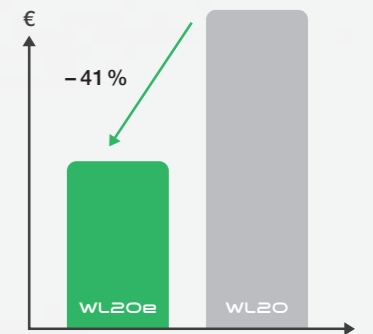

\* Taken into consideration are energy and service costs as well as a battery replacement for the WL20e after about 1,200 charging cycles.

	WL20e
Bucket capacity	0.20 m <sup>3</sup>
Operating weight:	2,350 kg
Engine output	6.5/9 kW**

\*\* Travel drive motor capacity S2 (60 minutes) / lifting motor capacity S3 (15%)

**Easy charging:** Connect battery connector with battery charger.



**2 batteries to choose from:** Running time of 2 to 5 hours depending on the application.



**Always in view:** The charge situation of battery is shown on the display.



**Tipping load 200 kg higher** than with a conventional machine.

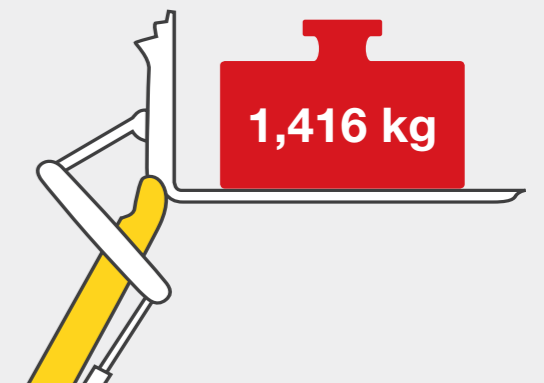

# WL20, WL25, WL32

There are bottlenecks on virtually every construction site. But you can go everywhere easily with the wheel loaders WL20, WL25 and WL32. For they are not only extremely maneuverable, but also designed to be extremely compact.

- Compact dimensions in width and height
- Easy maneuvering thanks to the small turning radius
- Powerful hydraulic system and matched engine output
- Numerous attachments for versatile application
- Comfortable cabin
- Various driver's cabins to choose from (see page 17)
- Optional: eps-canopy for particularly low passage heights

**Easy to transport:** suitable for trailers thanks to a weight of 2.3 tons.

	WL20	WL25	WL32
Bucket capacity	0.20 m <sup>3</sup>	0.35 m <sup>3</sup>	0.45 m <sup>3</sup>
Operating weight:	2,000 kg	2,380 kg	3,400 kg
Engine output	17.9 kW	24.6 kW	36.3 kW



**Ideal for foot paths:** available from a width of 960 mm.



**Compact and powerful:** up to 100 liters of hydraulic fluid available for enhanced performance.

**Year-round application – e.g.** with a snow blade in the winter.



**Folded down quickly:** the operator's canopy (Easy Protection System).



**Compact dimensions –** ideal when it comes down to centimeters.

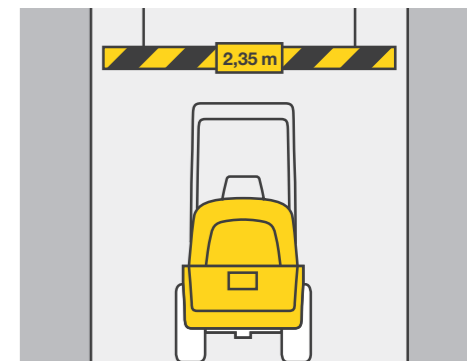

**Whether a garage or building entrance:** Low passage heights are not an obstacle.

# WL34, WL38

The combination of efficiency output and compact dimensions is required for many application areas of wheel loaders. The WL34 and the WL38 offer you just that.

- Very compact dimensions
- Ideal combination of P and Z kinematics
- Transport on truck or in container thanks to the cabin height of less than 2.5 meters (for WL34)



**Economical and sturdy** – the ideal entry-level model in its class.

	WL34	WL38
Bucket capacity	0.6 m <sup>3</sup>	0.6 m <sup>3</sup>
Operating weight:	3,270 kg	4,200 kg
Engine output	35.7 kW	36.3 kW



**Exhaust emission standard level IIIa or IIIb:** overall three high horsepower engine versions to choose from.

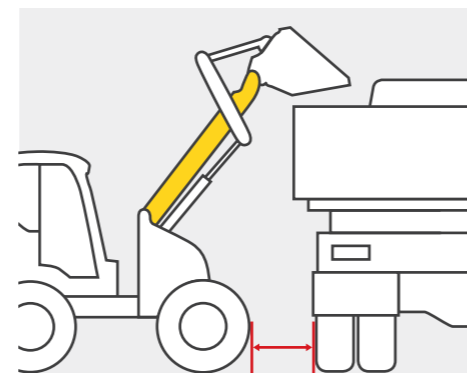

**Effortless loading**, even with high sides, thanks to the load arm with a large lift height.



**PZ-kinematics** allows good shearing forces and finely coordinated parallel guidance.



**Even manages 1.6 tons** due to optimal weight distribution.

# WL44, WL54

Whatever the task is on the construction site:  
Simply rely on the WL44 and WL54.

These machines are powerful all-rounders that can master just about anything.

- Cost-effective technology for a high level of productivity
- Large reach when loading
- Moves high volumes
- The long load arm makes central heap-up possible, even with high side loading gates

	WL44	WL54
Bucket capacity	0.75 m <sup>3</sup>	0.95 m <sup>3</sup>
Operating weight:	4,390 kg	5,230 kg
Engine output	45 kW	55.1 kW



**Is used everywhere:**  
thanks to the large lift height.

**Convincing** – in any application on the construction site.

# WL52

Man and machine are equally challenged for large quantities of material. The WL52 is perfectly designed for many loading cycles. The operator is also spared during the long workday through comfort functions.

- Enormous efficiency output
- Very high shearing forces through the large-sized tipping cylinders
- Smooth and effortless joystick pilot control for fatigue-free working
- Two different high cabin types

	WL52
Bucket capacity	0.75 m <sup>3</sup>
Operating weight:	5,100 kg
Engine output	55.4 kW



**Agile powerhouse** – plenty of power for any task.

**Engine pre-heating** for reliable application in the cold season.



**High bucket breakaway force** for large volumes due to the Z-kinematics.



**Digging bucket with ripper teeth** for powerful applications.



**Optionally large cabin** with the best view of the attachment.



# WL60, WL70

Wheel loaders do not just need to convince in terms of performance efficiency, but also in terms of consumption and operating comfort. Innovative solutions therefore make the WL60 and WL70 role models in their class.

- Ideal for urban work thanks to engine technology that meets the latest exhaust emission standard level III B
- Optionally available flow sharing makes it possible to operate several work functions simultaneously, such as lifting, rolling in, etc.
- Sturdy load arm design
- Optional load sensing: Load pressure reporting system for lower energy consumption, since hydraulic fluid is guided directly to where it is needed at 150 l/min and the system does not follow-on while driving
- If desired, electrical functions of attachments are controlled via the joystick

	WL60	WL70
Bucket capacity	0.95 m <sup>3</sup>	1.1 m <sup>3</sup>
Operating weight:	5,900 kg	7,000 kg
Engine output	75 kW	86 kW

Optional engines with different power output: 75/86 kW.



High stability due to 7 tons overall weight.



Directly on the joystick: proportional hydraulic control system for 3rd and 4th control circuit.



Always stable – due to optional weight distribution.



With the 4-in-1 bucket, the bulk material can be picked up and spread evenly.

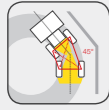

## Articulated pendulum joint

Tight curves, small gradients – every construction site is different. An articulated pendulum joint provides important services for being able to bring the transported material safely to destination. It provides for the best possible stability and maneuverability. This also allows you to work efficiently and safely with even little space.



**Maximum traction:** All wheels remain in contact with the ground.

An articulated pendulum joint allows a 45° angle.

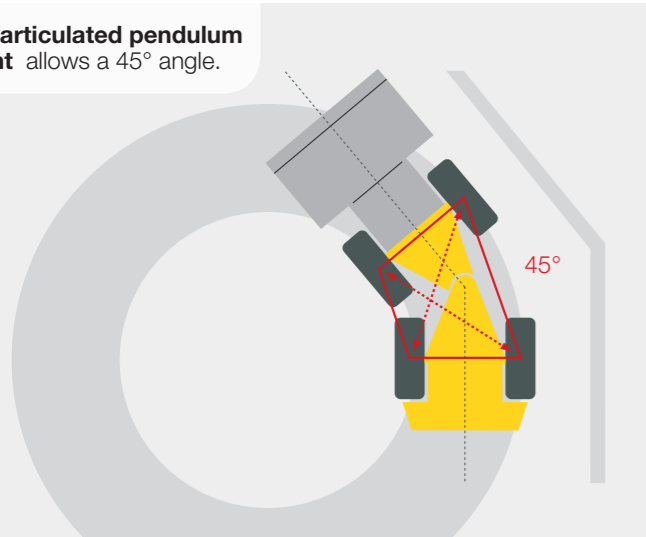

## Differential lock

The 100% engageable differential lock makes it possible to work reliably on difficult surfaces. The result: maximum thrust with excellent traction.

The lock is not enabled during normal driving operation. This protects the tires from unnecessary wear and also protects the surface being driven on.

All wheel loaders from Wacker Neuson have a differential lock (WL20 optional).



The differential lock is easily engaged only as you need it.



The differential lock provides good traction in both axles.

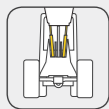

## Two lift cylinders

For even more stability of the loading system, all wheel loaders from Wacker Neuson are equipped with two lift cylinders. The load is thus optimally distributed on the load arm.



## Brake-inch pedal

Full power for the hydraulics and at the same time reducing the travel speed: To do this, you only need one pedal with the Wacker Neuson wheel loaders. You can regulate both mechanical as well as hydraulic braking ("inching") via the brake-inch pedal.

The advantages stand out a mile: Less wear on the service brake as well as optimal performance distribution of the engine output.

All wheel loaders from Wacker Neuson have a brake-inch pedal.

### Brake-inch pedal: Engine output where it is needed.

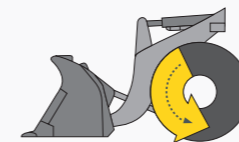

**No pressure on the brake-inch pedal:** full power for the travel drive.

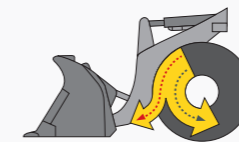

**Slightly depressed brake-inch pedal:** The speed is reduced, more power to the work hydraulics.

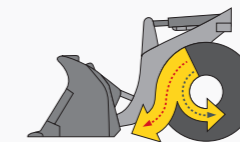

**Strongly depressed brake-inch pedal:** The speed is reduced further, even more power to the work hydraulics.

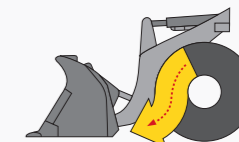

**Fully depressed brake-inch pedal:** The wheel loader stands still, full power to the work hydraulics.

## Cabin

Comfort and a high degree of ergonomics in the cabin should allow the operator to work for hours fatigue-free and productively. The spacious cabins are, for example, well-dampened to offset vibrations. Depending on the model, there are additional intelligent functions, such as the joystick, which puts many functions in one of the operator's hands.



## Driver's cabins

All three driver's cabins of the Wacker Neuson wheel loaders are perfectly designed for the requirements of everyday construction site life and meet high safety standards.

- ROPS-protection (roll-over protective structure)
- FOPS-protection (falling object protective structure)

## Maintenance

Open service access to hydraulics, engine and air cleaner: Depending on the model, you only need to carry out a few steps with the laterally tiltable driver's cabin as well as easy-to-open service flaps. The quick maintenance shortens downtimes and you therefore save money.



Comfortable work: air-cushioned comfort seat and adjustable steering wheel.



Adjustable joystick console swings along with the operator's seat.



## Cabin



Good 360°-view and the loaded material always in view.



## Fixed operator's canopy



Pleasant working climate thanks to the gap ventilation, good air circulation and optional air-conditioning system.



Fold-down operator's canopy for WL20 and WL25 eps (Easy Protection System).



## Long service life

You can rely on the best quality down to the last detail. A high material thickness of the load arms ensure reliable stability. The powder-coating also makes it sturdy against mechanical impacts and corrosion.



## Attachments

The tasks for wheel loaders are varied and so the attachments from Wacker Neuson are also varied. With our comprehensive and sophisticated product range, you will make a multifunctional machine out of any model.

3 different  
ATTACHMENT  
HOLDING  
FIXTURES

### The exact specifications and availabilities of attachments differ depending on the model and country. Your Wacker Neuson partner is happy to help you.



## Tires

The appropriate wheel loader tires play an important role in specific applications. Everything runs perfectly if the tires are optimally matched to the surface and application area. Four treads are available to choose from.

### Tread selection for wheel loaders



#### RP tread

- Gentle driving on the ground due to the large contact surface
- For use on lawns



#### AS tread

- Tapered lamellas
- For smeary and very dirty surfaces



#### EM tread

- Parallel-running lamellas
- Large contact surface and therefore good thrusting force transmission and high running smoothness on the street
- For loose surfaces, such as sand, gravel or crushed stone



#### MPT tread

- Very broad application spectrum
- Good traction in uneven ground conditions
- Allows for quick road crossings



The exact specifications and availabilities of tires differ depending on the model and country. Your Wacker Neuson partner is happy to help you.

Work efficiently with the right attachment.



Hydraulic tool change directly from the operator's seat.



Reliable advance, even on sandy soils.



Show profile: We offer you tires for any ground - such as gravel.



# Standard equipment and options

WHEEL LOADERS

	WL20e	WL20	WL25	WL32	WL34	WL38	WL44	WL52	WL54	WL60	WL70
<b>ENGINE</b>											
Perkins 403D-15 23.4 kW	-	○	-	-	-	-	-	-	-	-	-
Perkins 403D-11 17.9 kW	-	●	-	-	-	-	-	-	-	-	-
Perkins 404D-15 24.6 kW	-	-	●	-	-	-	-	-	-	-	-
Perkins 404D-22 36.3 kW	-	-	-	●	●	●	-	-	-	-	-
Perkins 404F-22T 44.7 kW	-	-	-	○	-	○	-	-	-	-	-
Deutz TCD 2.9 L4 55.4 kW	-	-	-	-	-	○	-	●	-	-	-
Deutz TD2011 L04w 55 kW	-	-	-	-	-	-	○	-	●	-	-
Deutz D2011 L04w 45 kW	-	-	-	-	-	-	●	-	-	-	-
Perkins 854E-E34TA 75 kW	-	-	-	-	-	-	-	-	-	●	-
Perkins 854E-E34TA 86 kW	-	-	-	-	-	-	-	-	-	○	●
Battery / electric motor drive system	●	-	-	-	-	-	-	-	-	-	-
<b>LIGHTING</b>											
Rotating beacon	○	○	○	○	○	○	○	○	○	○	○
Work lights, 2 in front, 2 in rear; WL20 (1 in rear)	●	●	●	●	●	●	●	●	●	●	●
LED work lights, 2 in front, 2 in rear; WL20 (1 in rear)	○	○	-	○	○	○	○	○	○	○	○
<b>ELECTRONICS</b>											
Front plug receptacle, 3-pole	○	○	○	-	○	-	○	-	○	-	-
Front plug receptacle, 7-pole	-	○	-	○	-	○	-	○	-	○	○
Rear plug receptacle, 7-pole	-	○	○	○	-	○	○	○	○	○	○
Front plug receptacle, with joystick control	-	-	-	○	-	○	-	○	-	○	○
Rear plug receptacle, 3-pole with lever	-	-	-	○	○	○	-	○	-	○	○
<b>FRONT AREA HYDRAULICS</b>											
Unpressurized front return line	○	○	○	○	○	○	○	○	○	○	○
3rd control circuit, in front DN12	-	○	○	●	-	●	-	●	-	-	-
3rd comfort control circuit	○	-	○	-	○	-	○	-	○	-	-
4. comfort control circuit	○	-	○	-	-	-	○	-	○	-	-
3rd control circuit proportionally controlled, parallel	-	-	-	●	-	●	-	●	-	●	●
3rd control circuit proportionally controlled, serial	-	-	-	○	-	○	-	○	-	○	○
4. Proportional-controlled control circuit	-	-	-	○	-	○	-	○	-	○	○
Hydraulic pump 22.5 ccm	-	-	-	○	○	○	-	-	-	-	-
Hydraulic pump 25 ccm	-	-	-	○	-	○	-	-	-	-	-
Hydraulic pump 32 ccm	-	-	-	-	-	-	-	●	-	-	-
Hydraulic pump 36 ccm	-	-	-	-	-	-	-	○	-	●	●
High flow single action	-	-	-	-	-	○	-	○	-	-	-
4th control circuit Flow Sharing	-	-	-	-	-	-	-	-	-	○	○
High Flow EW 150 I Load-Sensing	-	-	-	-	-	-	-	-	-	○	○

● Standard ○ Option - not suitable

WHEEL LOADERS

	WL20e	WL20	WL25	WL32	WL34	WL38	WL44	WL52	WL54	WL60	WL70
<b>REAR AREA HYDRAULICS</b>											
Rear hydraulic connection, single-acting	-	○	○	○	○	-	○	-	○	-	-
Rear hydraulic connection, dual-acting	-	○	-	○	-	○	-	○	-	○	○
Rear hydraulic connection, electrical valve	-	-	○	-	-	-	-	-	-	-	-
Unpressurized rear return line	-	-	○	○	-	○	-	○	-	○	○
Rear hydraulic connection, additional, single-acting	-	-	-	○	-	○	-	○	-	○	○
Rear hydraulic connection, additional, dual-acting	-	-	-	○	-	○	-	○	-	○	○
<b>DRIVER'S CABIN</b>											
Operator's canopy eps (Easy Protection System), ROPS- and FOPS-tested	○	○	○	-	-	-	-	-	-	-	-
Low operator's canopy, ROPS- and FOPS-tested	-	●	●	●	●	-	-	-	-	-	-
High operator's canopy, ROPS- and FOPS-tested	●	-	-	-	○	-	●	-	●	-	-
Low cabin	-	-	-	○	○	●	-	○	-	-	-
High cabin	-	○	○	-	○	-	○	●	○	-	-
High cabin comfort	-	-	-	-	-	○	-	○	-	●	●
<b>OTHER</b>											
Air-conditioning system	-	-	-	○	-	○	-	○	-	○	○
Load arm vibration dampening	-	-	-	○	○	○	○	○	○	○	○
Central lubrication system	-	○	○	○	○	○	○	○	○	○	○
Hand inching	-	-	○	○	-	○	-	○	○	○	○
Engine pre-heating 230 V	-	○	○	○	○	○	○	○	○	○	○
Approval as tractor unit D*	-	-	-	○	○	○	○	○	○	○	○

\* please contact Wacker Neuson for other countries

# Technical data

		WL20e	WL20	WL25	WL32	WL34	WL38	WL44	WL52	WL54	WL60	WL70
<b>ENGINE</b>		<b>UNIT</b>										
<b>Manufacturer</b>	–	–	Perkins	Perkins	Perkins	Perkins	Perkins/Deutz	Deutz	Deutz	Deutz	Perkins	Perkins
<b>Max. engine output</b> (optional)	<b>kW</b>	–	17.9 (23.4)	24.6	36.3 (44.7)	35.7	36.3/44.7/55.4	45/55.1	55.4	55.1	75 (86)	86
<b>Max. engine output</b> (optional)	<b>HP</b>	–	24 (32)	33	50 (60)	49	50	61/75	75	75	102 (117)	117
<b>at max. RPM</b> (optional)	<b>rpm</b>	–	2,800 (2,600)	2,800	2,800	2,600	2,800/2,800/2,300	2,300	2,300	2,300	2,500	2,500
<b>Displacement</b> (optional)	<b>cm³</b>	–	1,131 (1,496)	1,508	2,216	2,216	2,216	3,619	2,900	3,619	3,400	3,400
<b>Travel drive motor</b> , capacity S2 (60 minutes)	<b>kW</b>	6.5	–	–	–	–	–	–	–	–	–	–
<b>Lifting motor</b> , capacity S3 (15%)	<b>kW</b>	9	–	–	–	–	–	–	–	–	–	–
<b>WEIGHTS</b>		<b>UNIT</b>										
<b>Operating weight</b> FSD/cabin	<b>kg</b>	2,350	2,000/2,250*	2,380/2,520*	3,400*	3,270	4,200/4,300**	4,390	5,100	5,230	5,900	7,000
<b>Bucket breakaway force</b> (according to ISO 14397-2)	<b>daN</b>	2,170	1,280	1,989	4,269	4,427	4,128	2,838	4,243	3,513	4,034	4,032
<b>Bucket capacity</b>	<b>m³</b>	0.2	0.2	0.35	0.45	0.6	0.6	0.75	0.75	0.95	0.95	1.1
<b>Bucket tipping loads</b> (according to ISO 14397) Loading frame horizontal – Machine straight	<b>kg</b>	1,348	1,240/1,330*	1,508/1,626*	2,013/2,216*	2,300	2,952/3,265**	2,851	3,208	3,002	3,777	4,753
<b>Pallet fork tipping loads</b> (according to ISO 14397) Loading frame horizontal – Machine straight	<b>kg</b>	1,089	903/1,095*	1,150/1,249*	1,732/1,902*	2,058	2,570/2,726**	2,339	2,687	2,710	3,330	4,185
<b>Driver's cabin</b> (optional)	–	FSD (eps, cabin)	FSD (eps, cabin)	FSD (eps, cabin)	FSD (cab)	FSD (cab)	Cabin	FSD (cab)	Cabin	FSD (cab)	Cabin	Cabin
<b>Travel speed</b> (optional)	<b>km/h</b>	0-15	0-20 (30)	0-20 (30)	0-20 (28)	0-20 (28)	0-20 (28)	0-20 (30)	0-20 (30)	0-20 (30)	0-20 (30)	0-20 (30)
<b>Fuel tank capacity</b>	<b>l</b>	–	20	45	65	55	65	90	82	90	105	105
<b>Hydraulic oil tank capacity</b>	<b>l</b>	18.5	20	27	35	65	50	80	66	80	95	95
<b>HYDRAULIC SYSTEM</b>		<b>UNIT</b>										
<b>Drive hydraulics</b> working pressure (optional)	<b>bar</b>	–	330 (450)	450	450	450	445	445	445	445	445	445
<b>Work hydraulics</b> discharge volume (optional)	<b>l/min</b>	32	30.8 (36.4)	45	56 (63-100)	49	56 (63-116)	64	73.6 (73-116)	103	100 (150)	100 (150)
<b>Work hydraulics</b> working pressure	<b>bar</b>	225	225	185	210	210	210	230	230	210	210	210
<b>DRIVE</b>		<b>UNIT</b>										
<b>Drive type / drive system</b>	–	electrically via universal joint shaft	hydrostatic via universal joint shaft	hydrostatic via universal joint shaft	hydrostatic via universal joint shaft	hydrostatic via universal joint shaft	hydrostatic via universal joint shaft	hydrostatic via universal joint shaft	hydrostatic via universal joint shaft	hydrostatic via universal joint shaft	hydrostatic via universal joint shaft	hydrostatic via universal joint shaft
<b>NOISE CHARACTERISTIC VALUES</b>		<b>UNIT</b>										
<b>Averaged sound power level</b> LwA	<b>dB (A)</b>	91.8	98.4	100.1/99.7	99.8	99.5	99.3	100.2	100.3	99.7	101	101
<b>Guaranteed sound power level</b> LwA	<b>dB (A)</b>	92	101	101	101	101	101	101	101	101	103	103
<b>Specified sound pressure level</b> LpA	<b>dB (A)</b>	76	84	85/82	82	75	78	78	78	75	78	78

\* with cabin \*\* values with optional Deutz engine

		WL20e	WL 20e
		Standard battery	Optional battery
<b>BATTERY</b>		<b>UNIT</b>	
<b>Battery voltage</b>	<b>V</b>	48	48
<b>Rated capacity K5</b>	<b>Ah</b>	240	300
<b>Battery weight</b> (±5%)	<b>kg</b>	394	450
<b>Charging time</b>	<b>h</b>	8	6
<b>Running time with hard long-time application</b> with heavy materials handling, uninterrupted operation	<b>h</b>	1.5*	2.1*
<b>Running time with normal activities</b> , uninterrupted operation	<b>h</b>	2-3.5*	2.8-4.5*
<b>Running time with normal activities</b> with interruptions (30 min. driving, 30 min. standstill)	<b>h</b>	up to 4*	up to 5*

\* The running times of the battery are strongly dependent on the respective application conditions, the job and the driving style. This may also mean that a longer running time can be achieved. The specified running times may also fall short in extreme cases. An interrupted operation (e.g. 30 min. driving, 30 min. standstill) prolongs the running time of the battery.

# Dimensions

WHEEL LOADER

		WL20e	WL20	WL25	WL32	WL34	WL38	WL44	WL52	WL54	WL60	WL70
DIMENSIONS		UNIT										
Standard tires		-										
Standard bucket		405/70-18 EM ET0 Water filling volume										
		Earth bucket 1,150 mm 0.2 m <sup>3</sup>	Earth bucket 1,150 mm 0.2 m <sup>3</sup>	Earth bucket 1,250 mm 0.35 m <sup>3</sup>	Earth bucket 1,400 mm 0.45m <sup>3</sup>	Earth bucket 1,650 mm 0.6 m <sup>3</sup>	Earth bucket 1,650 mm 0.6 m <sup>3</sup>	Earth bucket 1,900 mm 0.75 m <sup>3</sup>	Earth bucket 1,900 mm 0.75 m <sup>3</sup>	Earth bucket 2,000 mm 0.95 m <sup>3</sup>	Earth bucket 2,000mm 0.95 m <sup>3</sup>	Earth bucket 2,200 mm 1.1 m <sup>3</sup>
A	Overall length	mm	3,721	3,721	4,087	4,755	4,960	5,138	5,606	5,489	5,968	5,898
B	Total length without bucket	mm	3,063	3,063	3,302	4,022	4,126	4,281	4,545	4,649	4,825	4,780
C	Center of axle up to bucket pivot point	mm	508	508	532	675	701	675	1,030	1,025	990	991
D	Wheel base	mm	1,468	1,468	1,612	1,952	2,020	2,045	2,005	2,008	2,150	2,150
E	Rear overhang	mm	975	975	1,045	1,290	1,296	1,516	1,445	1,531	1,520	1,676
F	Height (min./max.)	mm	2,209	1,880-2,302*	1,877-2,291*	2,336/2,348*	2,248/2,335*	2,371/2,548*	2,358/2,395*	2,495/2,672*	2,462/2,499*	2,693
H	Seat height	mm	1,245	1,225	1,259	1,354	1,169	1,204	1,295	1,559	1,341	1,609
J	Total working height	mm	3,294	3,274	3,582	3,715	3,901	4,007	3,906	4,025	4,385	4,409
K	Max. height of the bucket pivot point	mm	2,713	2,693	2,862	3,208	3,222	3,251	3,259	3,358	3,612	3,686
L	Overhead loading height	mm	2,444	2,424	2,573	2,954	2,984	2,892	2,957	3,029	3,248	3,375
M	Dumping height	mm	2,031	2,011	2,047	2,425	2,444	2,379	2,327	2,521	2,570	2,841
N	Reach with M	mm	330	350	337	252	344	155	867	625	963	799
O	Scraping depth	mm	94	94	50	50	33	120	183	113	210	73.5
P	Overall width	mm	1,076	1,076	1,210	1,414	1,570 (1,415)	1,570	1,730 (1,530)	1,874	1,752 (1,750)	1,829
Q	Track width	mm	810	810	940	1,148	1,260 (1,125)	1,200	1,405 (1,240)	1,361	1,427 (1,422)	1,422
S	Ground clearance	mm	207	207	250	275	294	312	290	364	315	375
T	Maximum radius outside	mm	2,681	2,681	2,912	3,534	3,510	3,652	3,866	3,943	4,213	4,341
U	Radius on outer side	mm	2,356	2,356	2,590	3,171	3,219	3,317	3,419	3,461	3,572	3,686
V	Inside radius	mm	1,219	1,219	1,330	1,731	1,745	1,640	1,688	1,538	1,688	1,666
W	Articulation angle	Degrees	45°	45°	45°	45°	45°	45°	44°	42°	44°	45°
X	Rollback angle at max. lift height	Degrees	50°	50°	48°	49°	54°	43°	45°	44°	49°	33°
Y	Max. angle for bucket emptying	Degrees	38°	38°	42°	44°	40°	42°	38°	39°	35°	33°
Z	Rollback angle on the ground	Degrees	48°	48°	46°	39°	48°	41°	43°	45°	39°	39°

\* depending on the driver's cabin (fixed operator's canopy, fold-down operator's canopy, cabin)

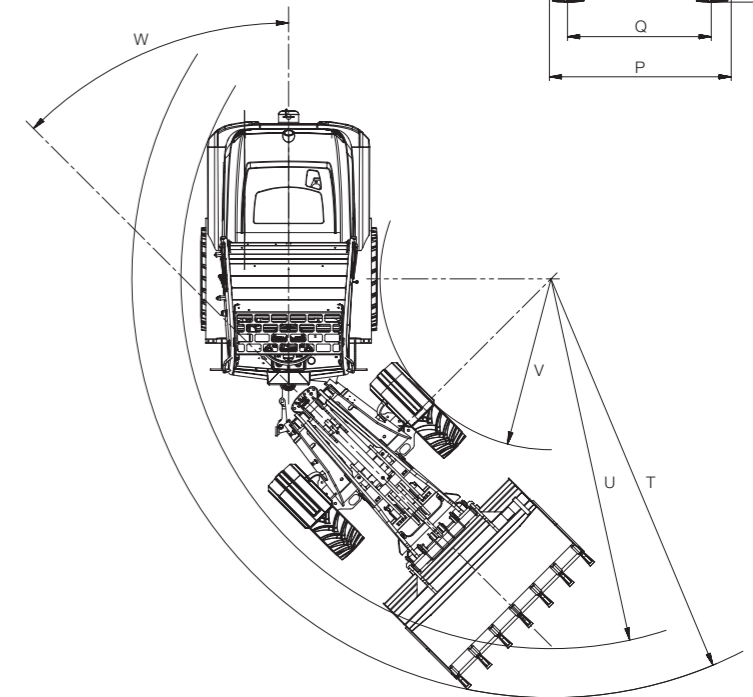
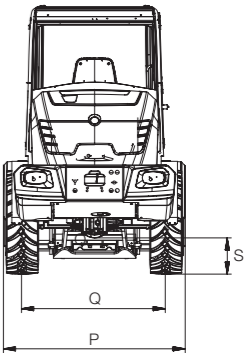
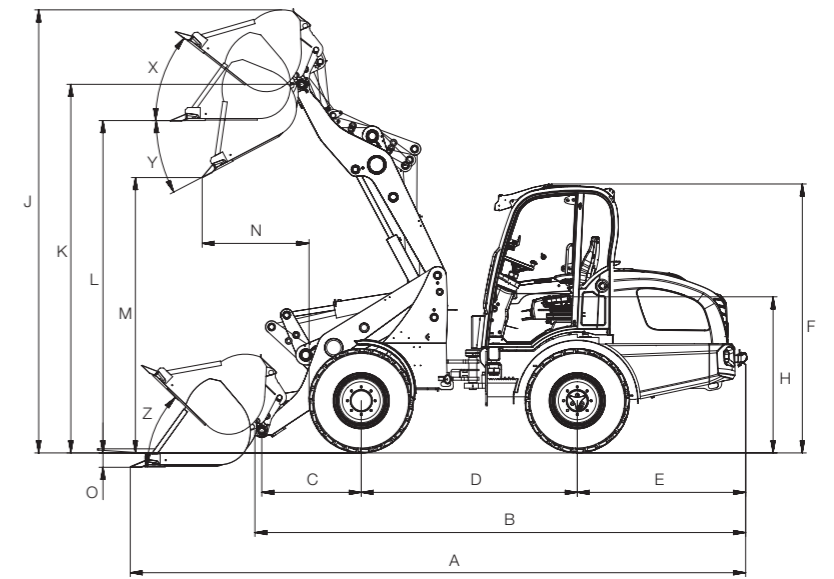

# Everything for your project.



**WACKER  
NEUSON**

Wacker Neuson offers you the complete range of solutions of powerful quality products combined with services that back you up in any situation.

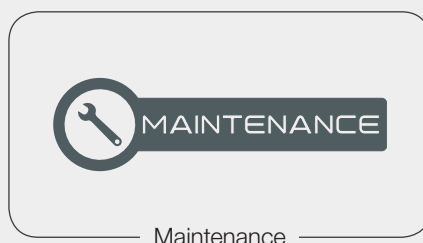
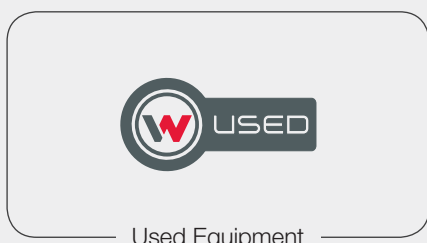
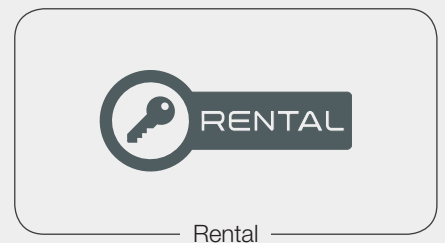
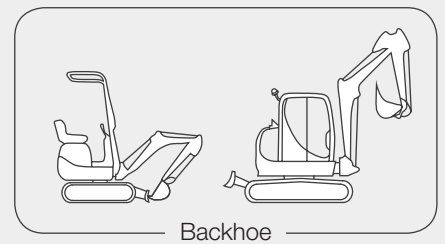
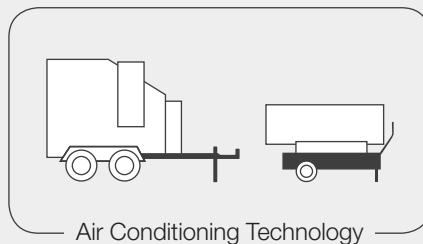
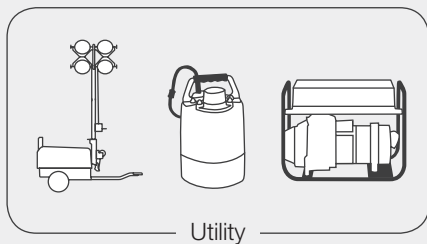
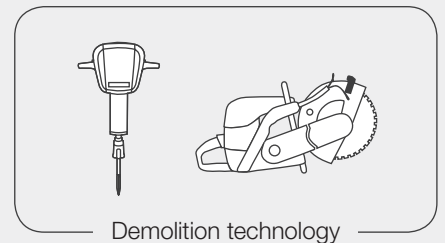
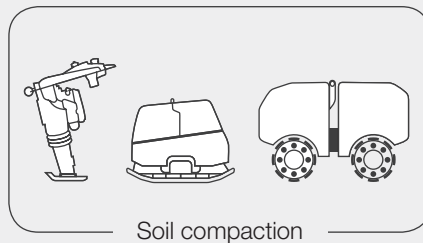
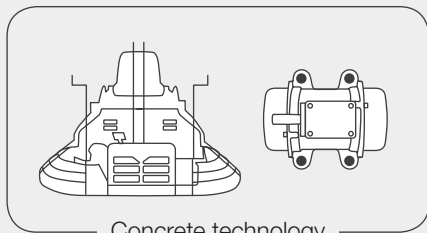

[www.wackerneuson.com](http://www.wackerneuson.com)